

Installation Instructions

1308128 28" LED Blade Guides

1. Loosely install the marker as shown below through a 1/2" hole
 - a. Adapter 1308126 may be used to adapt to vertical surfaces/plow ribs.
2. Orient the ground wire eyelet appropriately and tighten the assembly.
 - a. To prevent galling, lightly coat threads with anti-seize compound and use only hand tools.
3. Install bullet connector into base of threaded stud.
4. Route wire along plow moldboard, sector, and A-frame and secure while avoiding all pinch points (e.g. pivot stops, stacking stops, trip springs, etc...)
 - a. Be sure to allow enough slack for moldboard trip, side to side pivot, and lift frame/a-frame extension.
 - b. During install, allowable wire length for side to side pivot is best found by pivoting the plow to the side opposite of the wire install. For example – pivot right while installing wire on left half of moldboard.
 - c. If the path of hydraulic lines is clear from chafing, then secure the wire to the hydraulic line using cable ties to route the cable from the A-frame to the lift frame and up towards the electrical tie in.

5. Connect the power and ground wires to appropriate sources.
 - a. Possible locations for connecting power to Illuminated Plow Markers
 - i. Tap/splice into the existing plow light positive wire and ground (parking light or low beam) Using the parking light circuit could act as a secondary turn signal.
 - ii. Connect positive to a separate switch. Ground at battery.
 - iii. Strobe function can be achieved with Buyers Products LED strobe controller (5621002) and a separate switch.

WARNING

- The power source must be fused. Failure to use a fused power source could result in fire or vehicle damage.
- Inspect your wiring regularly for chafing/damage.

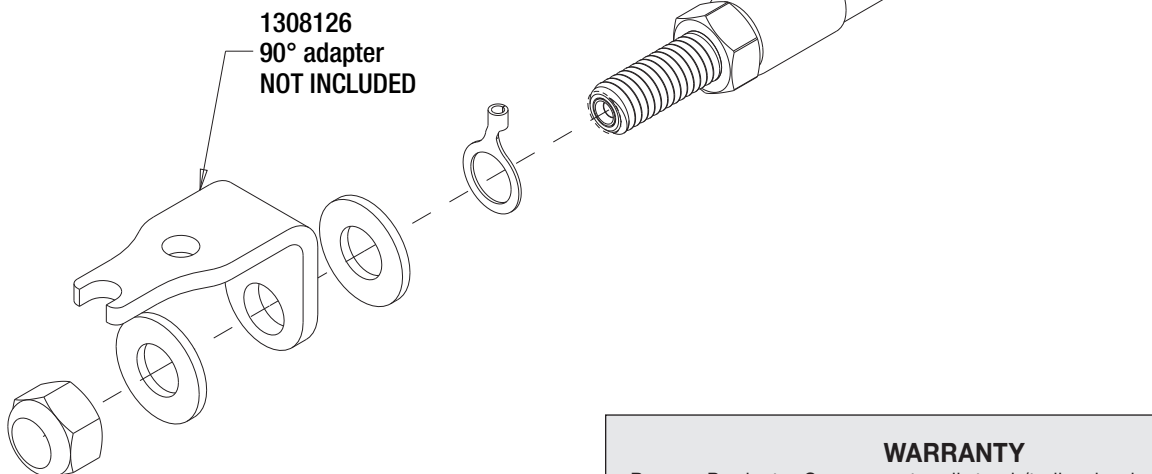

Replacement Parts

PART NO.	DESCRIPTION
3041133	Marker, 28in., Base Assy Only
3041349	Harness, Plow Marker, 12ft

Optional Parts Not Included

PART NO.	DESCRIPTION
1308126	Adaptor Kit, Horizontal
5621002	LED Strobe Controller

WARRANTY

Buyers Products Co. warrants all truck/trailer hardware manufactured or distributed by it, to be free from defects in material and workmanship for a period of one year from date of shipment. Parts must be properly installed and used under normal conditions. Any product which has been altered, including modification, misuse, accident or lack of maintenance will not be considered under warranty. Normal wear is excluded. The sole responsibility of Buyers Products Co. under this warranty is limited to repairing or replacing any part or parts which are returned, prepaid, and are found to be defective by Buyers Products Co. Authorization from Buyers Products Co. must be obtained before returning any part. No charges for transportation or labor performed on Buyers' products will be allowed under this warranty.